

PHILIPS

UniStreet gen2

Road & Street lighting



Re-engineered
to meet your
evolving needs
and **expectations**





Do you know that...

We are urban, we are global

Today 50% of the world's population lives in cities. This is expected to rise to 75% by 2050.

We are environmentally aware

Cities want to meet their sustainability goals by reducing light pollution.

We want our city to be unique

Municipalities want to offer quality of life and citizen well being. One way of achieving those goals is by creating comfortable public spaces.

We are connected

There are new opportunities to improve urban life through intelligent lighting such as Interact City.

Contents

4

Introduction



6

Meet UniStreet gen2

8

Application areas

10

LEDGINE optimized

12

Designed for serviceability

14

Future ready and easily serviceable



16

System ready architecture

18

Product specifications

19

Dimensional drawings



UniStreet gen2

The new generation of UniStreet is all about design, future-proof components and a best-in-class light engine with a wide range of optics. With all the strengths of its predecessor combined, the second generation is designed to further minimize your Total Cost of Ownership.

Increasing numbers of municipalities are upgrading large-scale conventional street lighting installations with energy efficient LED technology, often with smaller budgets. The new generation of UniStreet has been upgraded and designed to provide a solution to this challenge - and much more. With greater attention to cost savings, we have improved installation and maintenance features. Access to the gear is from the top of the fitting. All key electric components are located on a plastic gear plate, which is offered as an additional option. Thanks to the electric plate, maintenance, when necessary,

is much faster and easier. Service tag is also very helpful when it comes to luminaire identification, and in addition can boost maintenance.

A very flexible spigot allows UniStreet gen2 to be installed at different angles even on old brackets and for installations with multiple sizes, a spigot reducer is also available. Compact and lightweight with low windage, UniStreet gen2 is the perfect solution for aging columns.

Meet UniStreet gen2

UniStreet gen2 offers a number of advantages, including high efficiency, low Total Cost of Ownership. Thanks to Service Tag the installation and maintenance never been easier. Moreover, the SR (System Ready) socket makes the luminaire future ready, so it can be paired with lighting control and software applications such as Interact City.



Sustainable

UniStreet gen2 has a compact design and is made of recyclable and durable materials. Furthermore UniStreet gen2 incorporates technologies that reduce energy consumption.



High quality of light

UniStreet gen2 delivers comfortable lighting without compromising on visibility and safety



Adaptable design

With its simple and pure design UniStreet gen2 blends seamlessly into a wide variety of road and street scenes and residential spaces.



Wide application coverage

From outdoor parking areas, to cycle paths to highways UniStreet gen2 is your answer. Thanks to the latest LEDGINE Optimized LED platform and its extensive range of optics UniStreet gen2 offers great performance. Furthermore with L-tune you can customize our lighting to fully fit your application's needs.



Attractive TCO

The second generation of UniStreet is designed to further minimize your Total Cost of Ownership. With greater attention to cost savings we have improved installation and maintenance issues.



Future-ready and easily serviceable

UniStreet gen2 is easy to service thanks to Service tag. And since it's System Ready, it can be paired with lighting control and software applications like Interact City.

Application areas

Different contexts need different light

From night life areas to cycle paths to motorways – different areas of the city have unique lighting needs. UniStreet gen2 can be effectively deployed in any environment and match to its lighting needs.

Illuminate outdoor parking areas



Light major, minor and provincial roads



Enhance safety on walkways, cycle paths and minor roads



Optimize lighting efficiency on highways



Road & Street lighting

UniStreet gen2

Application areas





LEDGINE optimized

The new generation LEDGINE offers a unique combination of standardization and customization, so you can tune lighting solutions to suit your exact needs. The three pillars that characterize the LEDGINE are standardized optics, standard engine and tailor-made solutions.

Standardized optics

Complete new optics range ensures a perfect fit for every application. The optics offer flexibility, enabling standardization over applications with outstanding performance across a wide range of geometries – as well as design parameters such as tilt and overhang. They are easy to use and distribution remains the same, so even after a LED upgrade you are assured of design continuity. The optics comply with national and European road lighting standards.

Standard engine

Using a standard engine across key portfolio means you can benefit from the latest LED upgrades to various products without changing light distributions. The flux packages are pre-defined across product ranges, including CLO options. Flux minimization is achieved by using the highest flux package (up to L96B10) per standard. And for upgrades, the lighting image is continued and the engine is available for your installed base. Easy configuration is assured thanks to the Service tag.

Tailor-made solutions

For tuned project solutions, we can support you with the exclusive L-Tune tool. It enables you to build the required flux to ensure the best balance between operational life, maintained flux, energy costs and product type. You can create your own standard by matching requirements to your own policy. For serviceability, the L-Tune program codes are linked to the Service tag.



Designed for Serviceability

Easy to service thanks to the Service tag: Unique QR-based identification system that appears on individual luminaires and their packaging 360° proposition simplifies installation and servicing
 Provides 24/7 access to luminaire and spare parts information
 Allows on-the-spot driver reprogramming by being System Ready, UniStreet gen2 is ready to be paired with existing and upcoming control and lighting management applications such as Interact City.

Why Service tag?



Easy access to relevant information

Improving installation process by providing easy access to product configuration information



More effective maintenance

Enabling more effective maintenance operations by identifying spare parts



Digital maintenance

Enabling you to pre-program spare parts to factory settings

“

The greatest value of the Service tag is that it enables us to **save precious time and avoid human errors.**”



Instant access to procedures, spare part list and programming

This tag features a QR-based identification system that gives you instant access to critical information during unpacking, installation, diagnostics, fault reporting and programming. Simply scan the tag with a smartphone or tablet running the Service tag app, and the contents of the box plus installation information are described. The tag also activates the five-year warranty. To assist in diagnosing breakdowns, scanning the tag provides the troubleshooting guide applicable to that luminaire. Sourcing spare parts and 'one touch' programming of parts to original settings can also be done using the app. It's that simple.

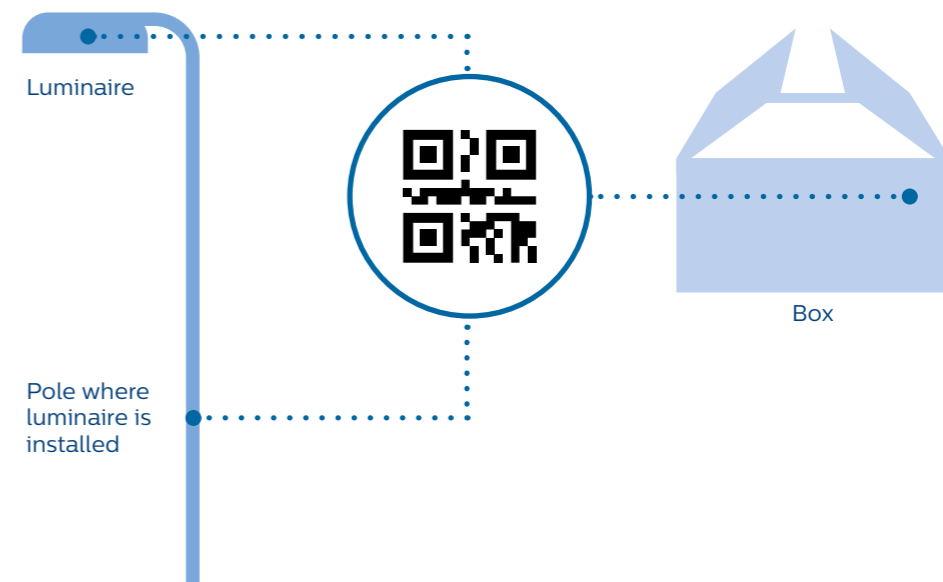

Future ready and easily serviceable

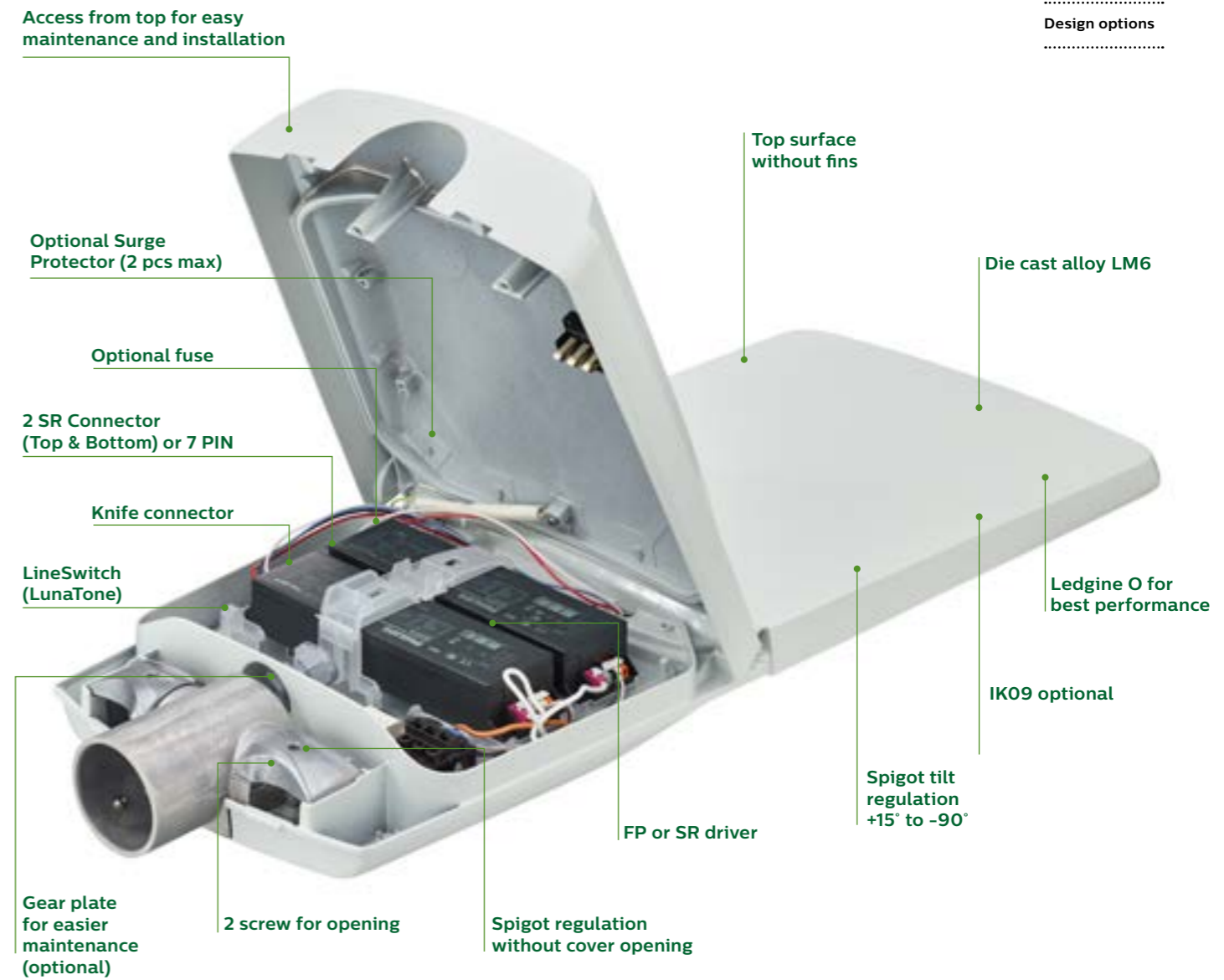

Attractive TCO

When it comes to Total Cost of Ownership, UniStreet stands out from the competition:

- Extremely efficient, offering a performance of up to 155 lm/W
- Wide range of fluxes from 600 lm to 40 000 lm
- A lifetime of up to 100,000 hours
- Reduced maintenance leads to significant cost savings compared to conventional street lighting
- Dimmable for further energy savings
- Ready to be connected to Interact City
- Ease of installation and maintenance enabled by the Philips Service tag



Philips Service tag

System ready architecture

The digital and smart city era is accelerating fast. To keep pace, cities need luminaires that are not only designed for today's technologies, but are prepared for future advances and upgrades. The System ready architecture gives you a scalable foundation that you can build on whenever your city is ready to opt into new advances in technology. So you can take light beyond illumination into a dynamic world of sensor-rich lighting - whenever you're ready.

Upgrade now or later

UniStreet gen2 is a System ready luminaire, coming with universal sockets on each luminaire, so all you have to do is click in controllers or sensors to activate new applications. That means you can install your luminaires today and mount controllers and sensors at a later date - without any hassle.



Future-proof upgrades

System ready luminaires can be paired with sensors and controllers now or later. A city solution that is completely flexible and scalable.



Plug and play

Designed for hassle-free installation, controllers and sensors can be mounted without opening the luminaire.



Standardized technology

Thanks to Zhaga standardization and the SR certified program, you will have access to preferred technology, allowing you to make use of innovations from different suppliers.



Aesthetic design

The small, unobtrusive form factor can be mounted discreetly on luminaires.

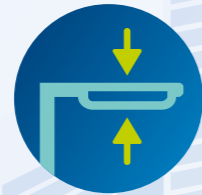

Flexibility

The SR socket can be mounted on the top, or on top and bottom of the luminaire, giving you the flexibility to choose from all sources of sensor applications. The IP66 rating also ensures there is no risk of water ingress.



Open innovation platform

Using this new System ready architecture gives you access to new innovations that could enhance your lighting even further in the future.

An open platform

Our System ready luminaires use state-of-the-art architectures and components. Because they are SR certified, they are compatible with all components released in our SR program. This ensures you'll always be ready for the latest innovations that will enable you to get more out of your lighting infrastructure.

Ready to be connected to Interact City

Interact City lighting management software turns your street lighting into a connected network capable of hosting sensors and other IoT-enabled devices. It allows you to tap into a wide range of lighting and non-lighting benefits such as dimming, presence detection, noise or air quality monitoring, and capturing incidents. Today, UniStreet gen2 is already ready to be connected to the Interact City lighting management software by simply twisting a controller.

For more information about Interact City visit: www.interact-lighting.com/city



Specifications

Product features	Specifications
Type	4 sizes: Micro, Mini, Medium, Large
LED engine	Ledgine 0
Power	8 to 300W
No of LED's:	Micro: 6; 10; 20 Mini: 20; 30; 40 Medium: 40; 60; 80 Large: 120; 60
Luminous flux for 4000k (lm)	Micro: 800 to 6 400 Mini: 3 400 to 12 000 Medium: 4 500 to 24 000 Large: 13 900 to 40 000
Luminaire efficacy	Up to 155 lm/W
IP	66
IK	08 or 09 (option)
CCT	3000K, 4000K, 5700K,
Useful Life	L90B10 100k hrs
Operating Temperature Range	-40° to +50° C
Mains Voltage	220-240V/50-60Hz
Dimming	LumiStep DynaDimmer DALI Coded Mains LightWave Mains Voltage AmpDimming LineSwitch RF Antenna EasyAir (Bluetooth module) WattStopper (presence detector) LightWave
Sockets	Top and Bottom SR Top 5/7 PIN Nema
Extra options	Fuse External Cable 4-22m Surge Protection Devices Internal Back Light Louvers External louvers Knife Connector Painted Spigot Marine Special Painting (1000hrs SST) Surge Protector 10kV (with SPD)
Optic	DM10, DM11, DM12, DM50, DN10, DW10, DW12, DW50, DW52 (other optics available upon request)
Optical cover	Cover: Glass, themally hardened
Materials	Housing: High pressure die-cast aluminum (EN AC-44300)
Color	Canopy: Gray (RAL 7035); other upon request
Connection	Push in connector or as option cable with external IP connector
Maintenance	Top access for instalation with 2 screw (underneath)

Dimensional drawings

UniStreet gen2 Micro

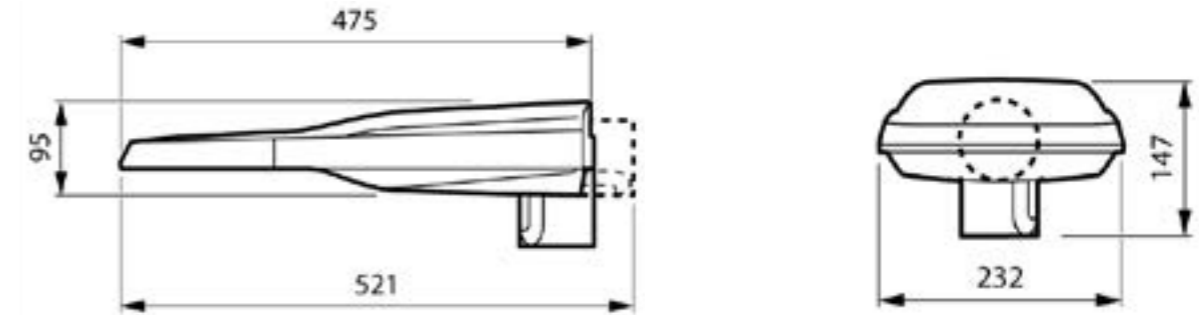

UniStreet gen2 Mini

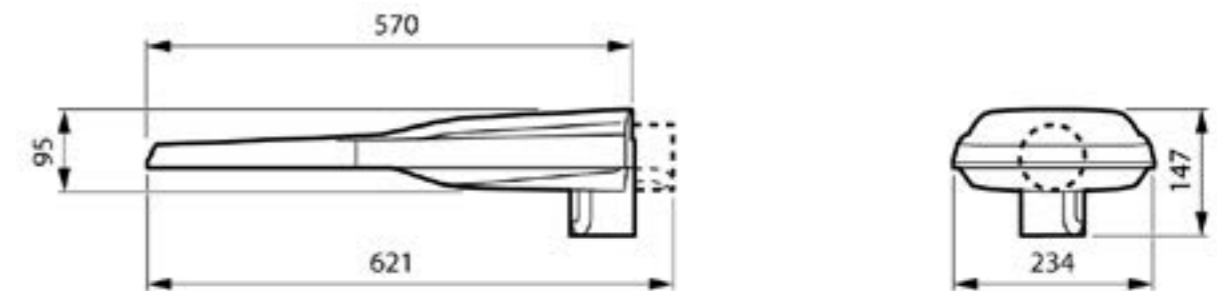

UniStreet gen2 Medium

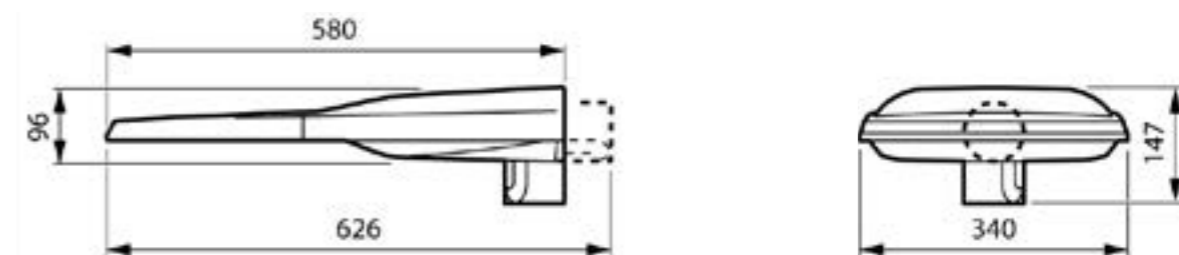

UniStreet gen2 Large

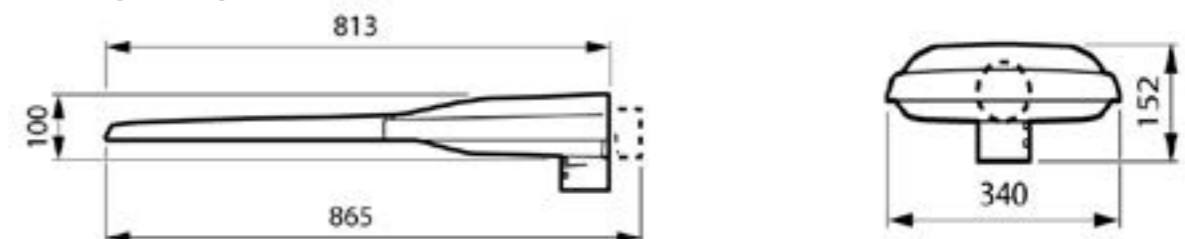



© 2019 Signify Holding. All rights reserved. The information provided herein is subject to change, without notice. Signify does not give any representation or warranty as to the accuracy or completeness of the information included herein and shall not be liable for any action in reliance thereon. The information presented in this document is not intended as any commercial offer and does not form part of any quotation or contract, unless otherwise agreed by Signify.

Philips and the Philips Shield Emblem are registered trademarks of Koninklijke Philips N.V. All other trademarks are owned by Signify Holding or their respective owners.

www.lighting.philips.com