

Siibrisõlm läbipesukaevu ja ühendustorustikuga

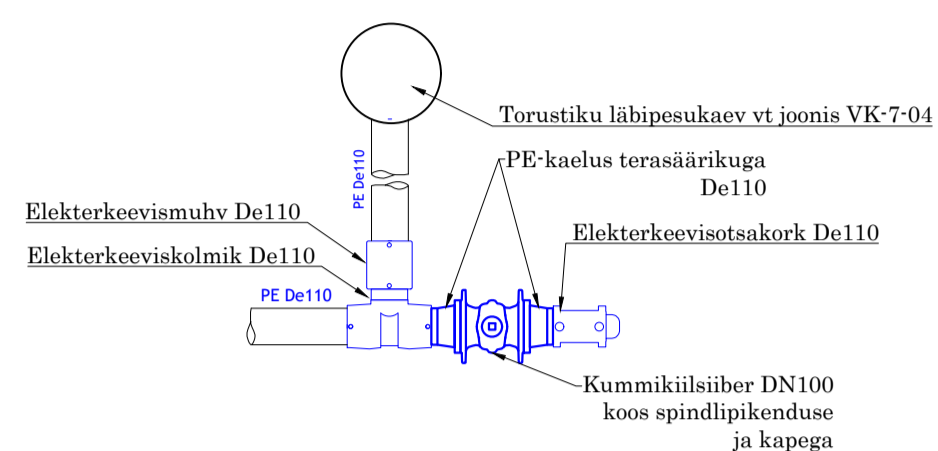

Magistraaltorustiku põlv

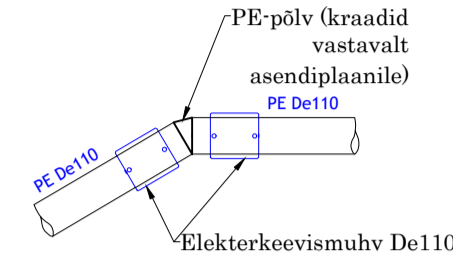

Põlv 90 kraadi De110

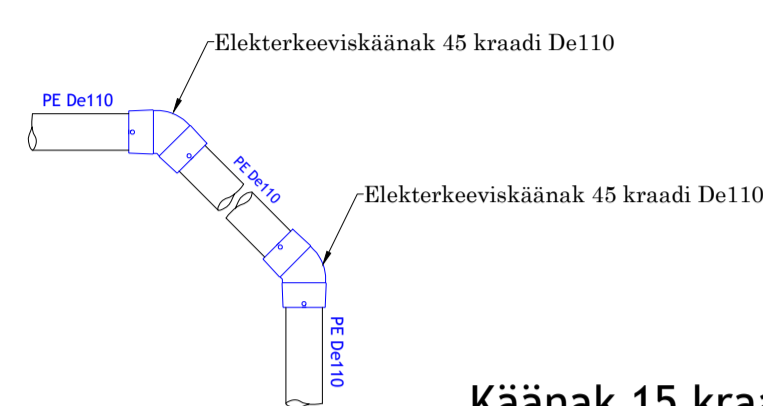

Käänak 45 kraadi De110

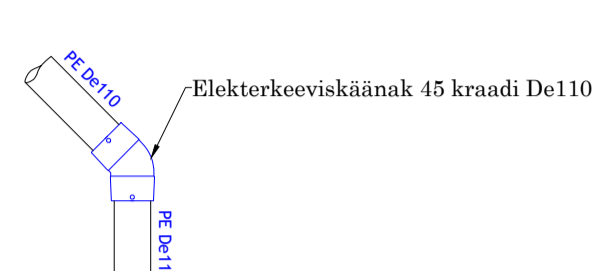

Majajühendustorustik, De63 hargnemine ja 2xDe110 siibrit

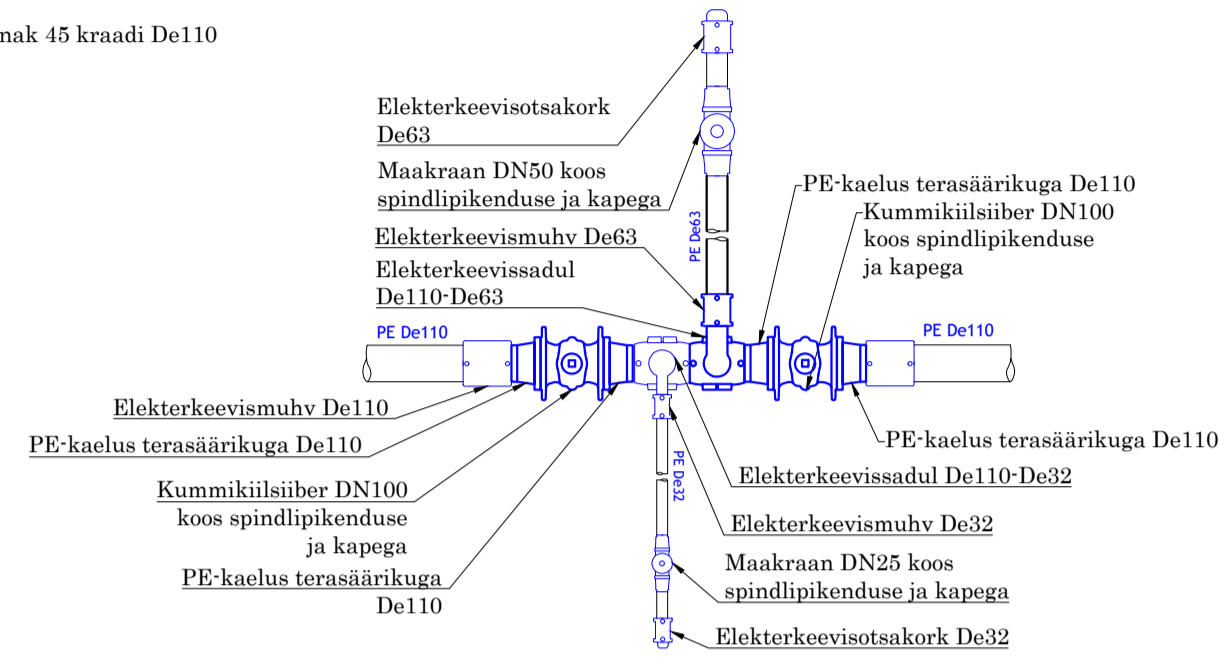

De110 majajühendus

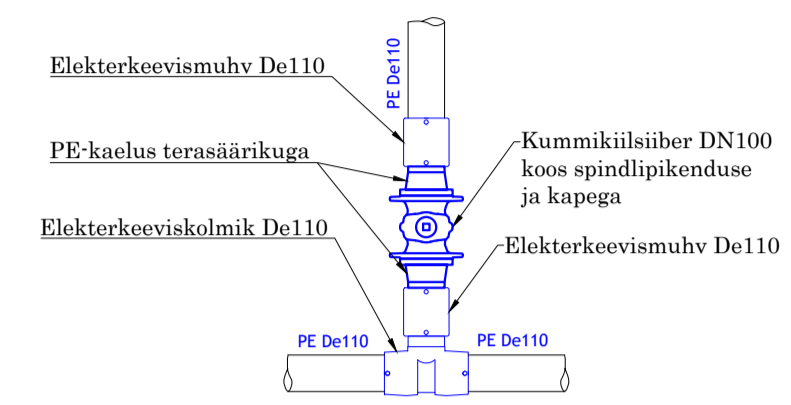

Tüüpsõlm - 3 siibrit

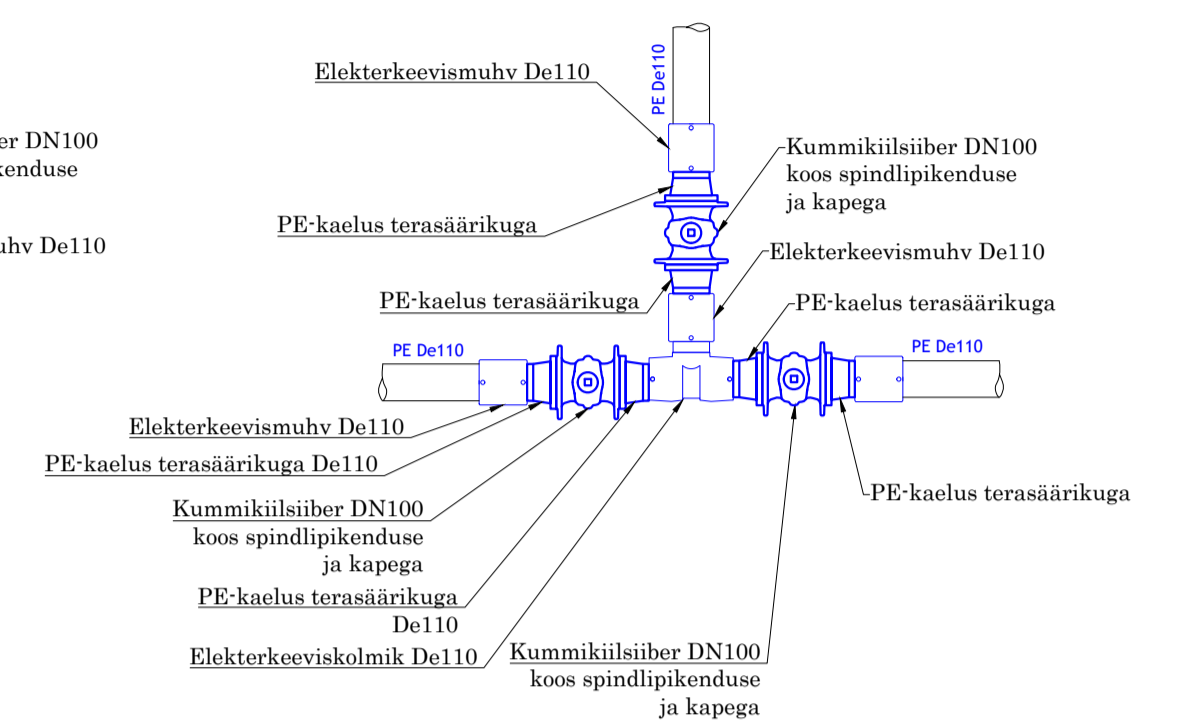

Majajühendustorustik

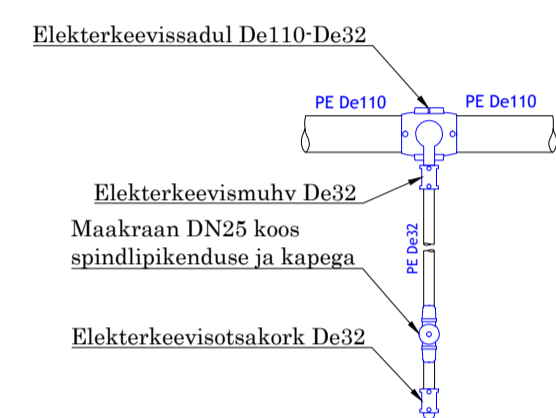

Majajühendustorustik 2 tk

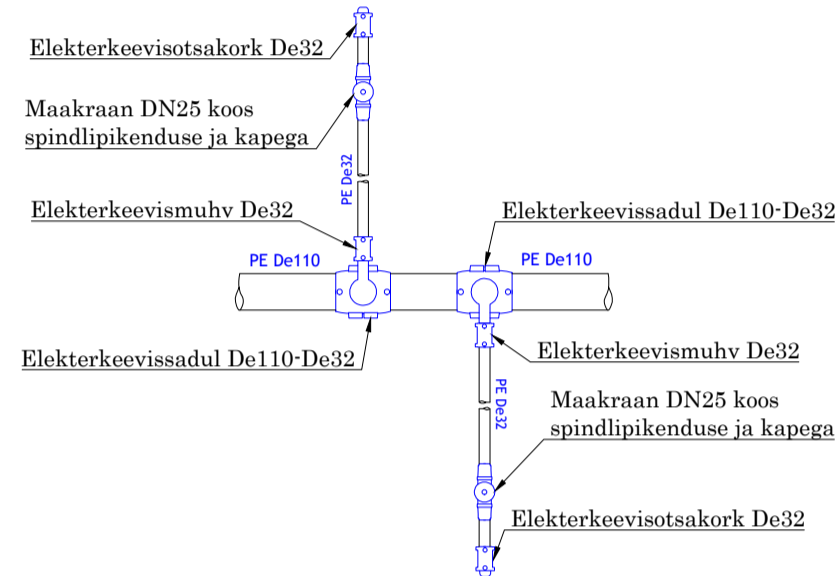

Käänak 15 kraadi De110

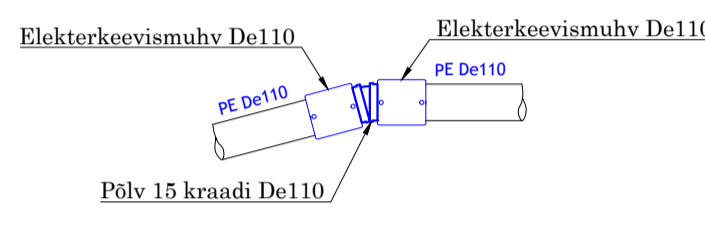

Majajühendustorustik ja 2xDe110 siibrit

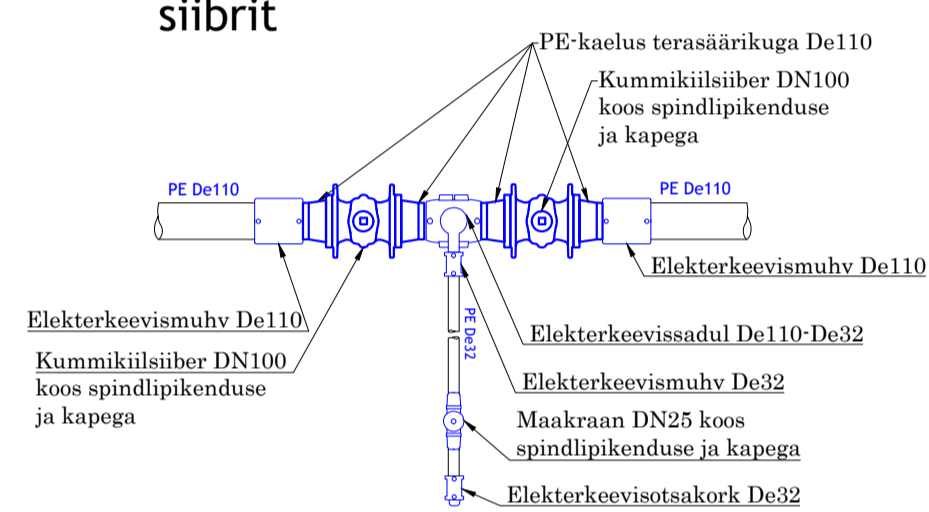

Siibrisõlm läbipesukaevu ja ühendustorustikuga

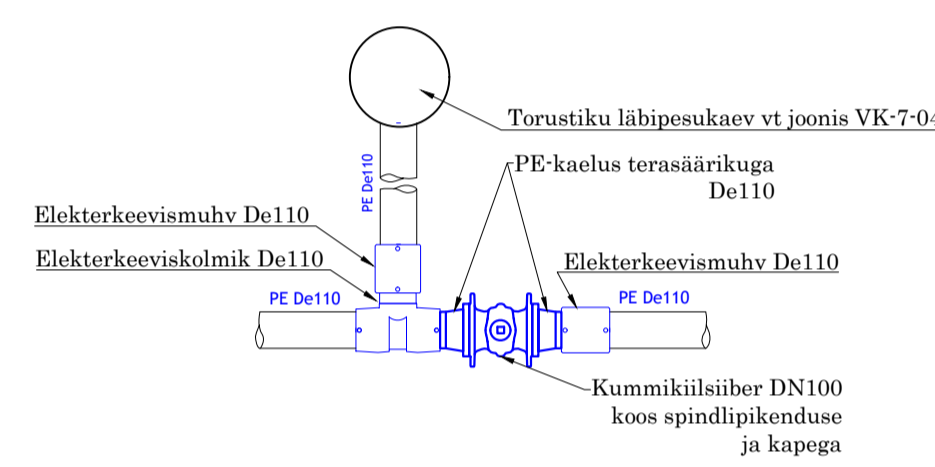

Siibrisõlm - 2 siibrit

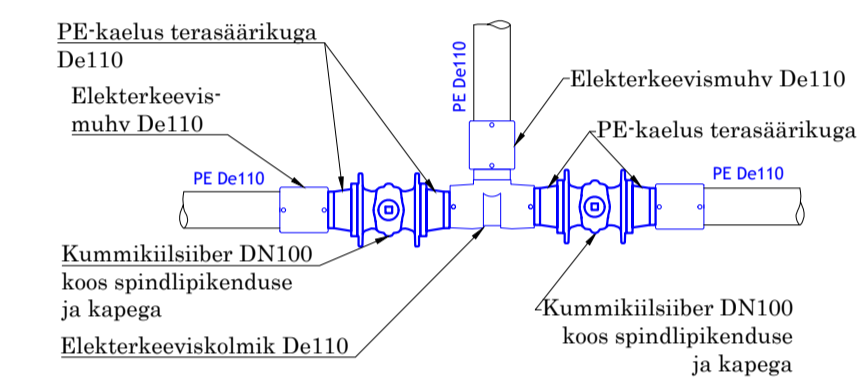

Majajühendustorustikud ja 1xDe110 siiber

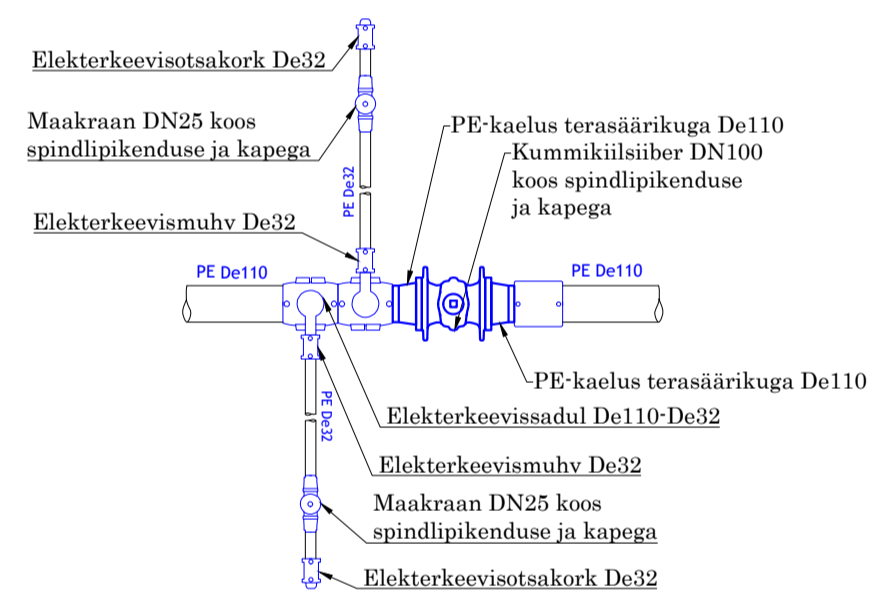

Majajühendustorustik, De63 hargnemine ja 1xDe110 siiber

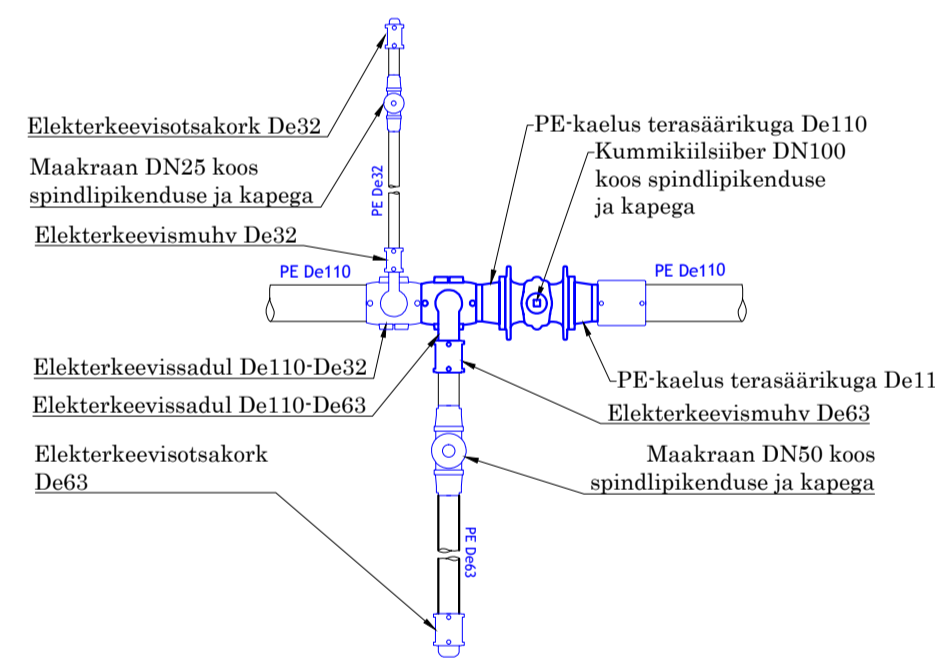

Siibrisõlm - 2 siibrit ja majajühendus

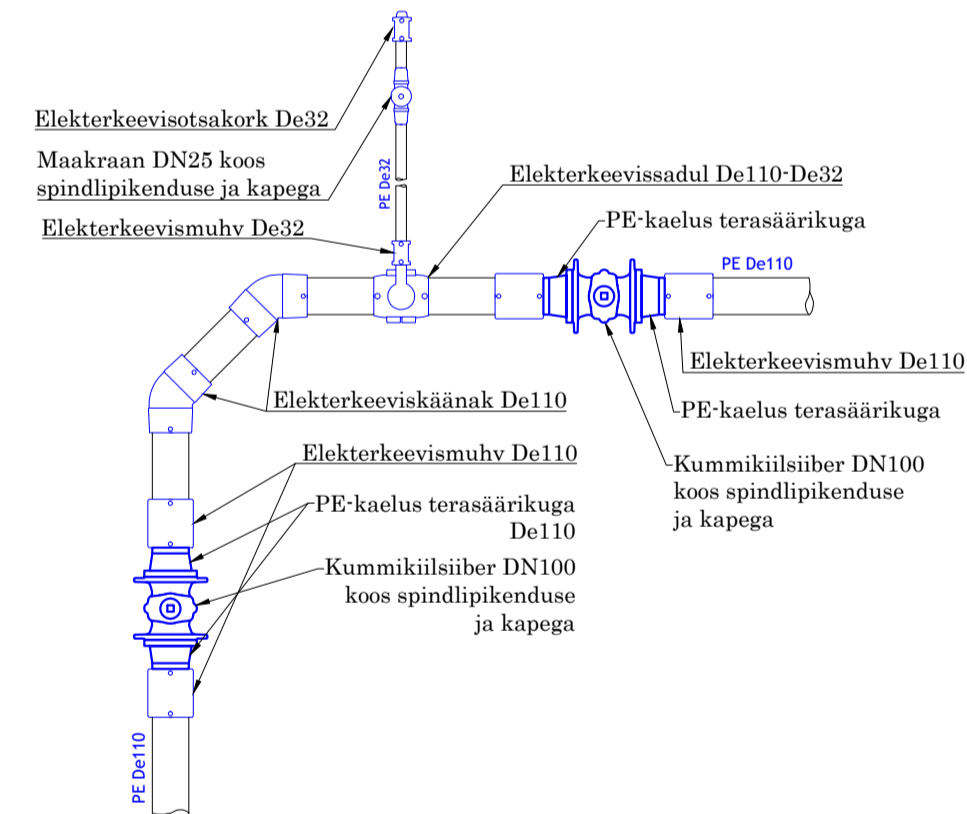

Läbipesukaev ja majajühendus

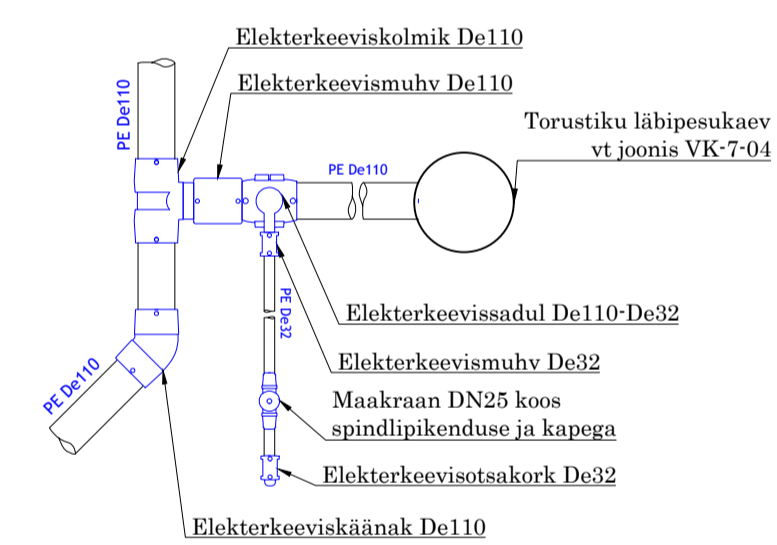

Kolmik - tüüpsõlm

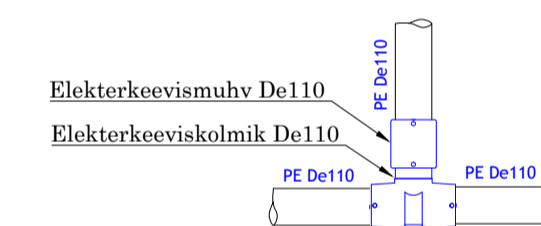

Siibrisõlm

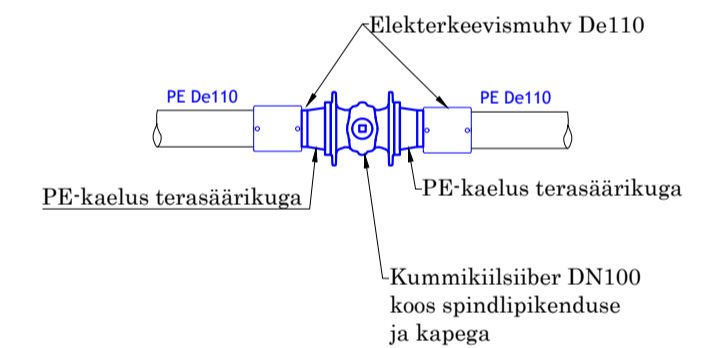

Hargnemine De63

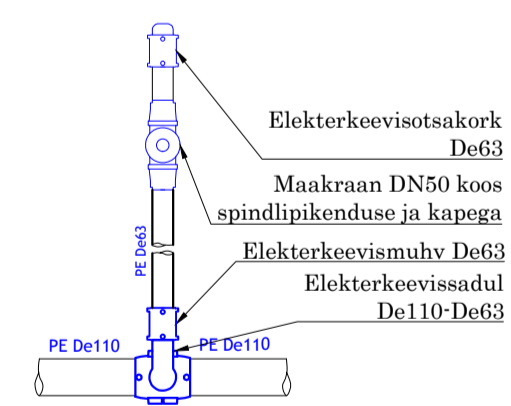

De63 hargnemine ja 1xDe110 siiber

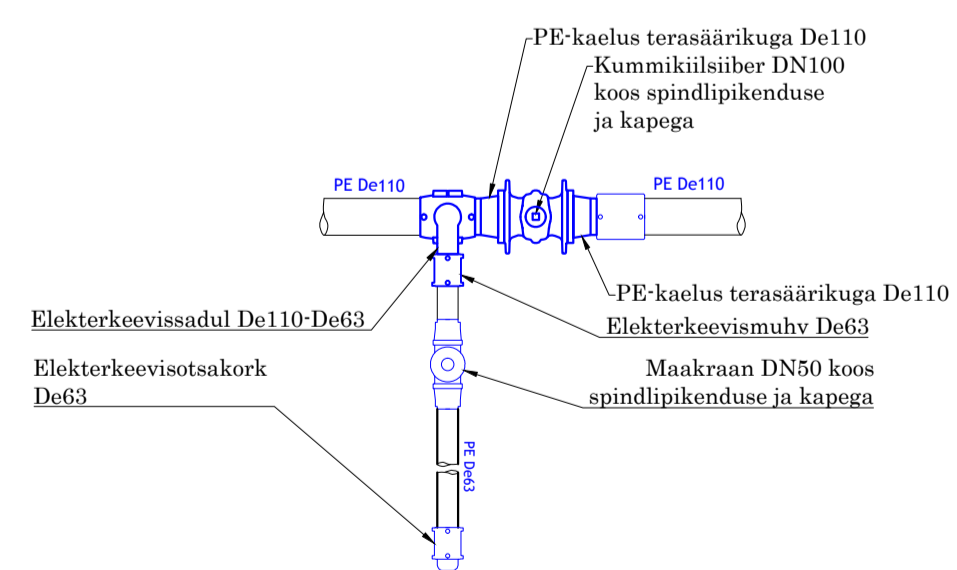

Siibrisõlm - 1 siiber

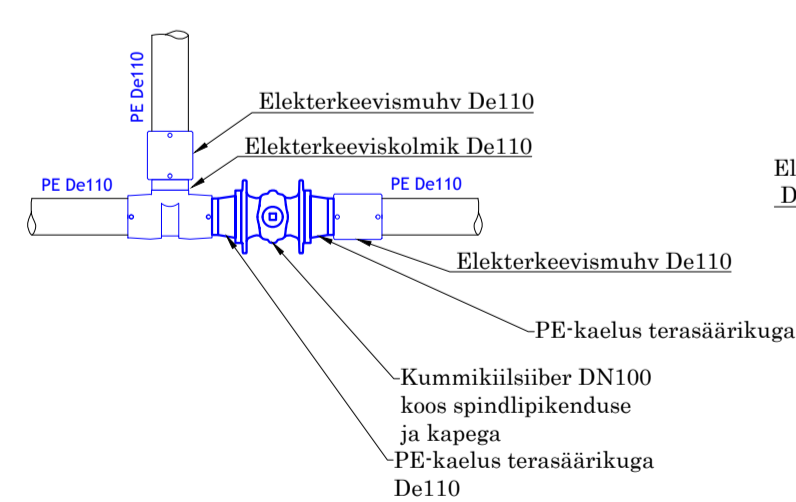

Torustiku läbimõõdu muutus

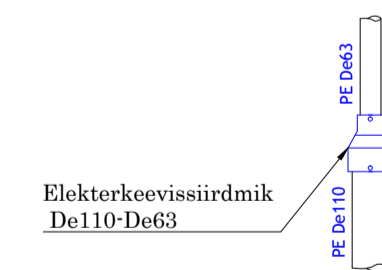

Majajühendustorustik De63 torut ja maakraan

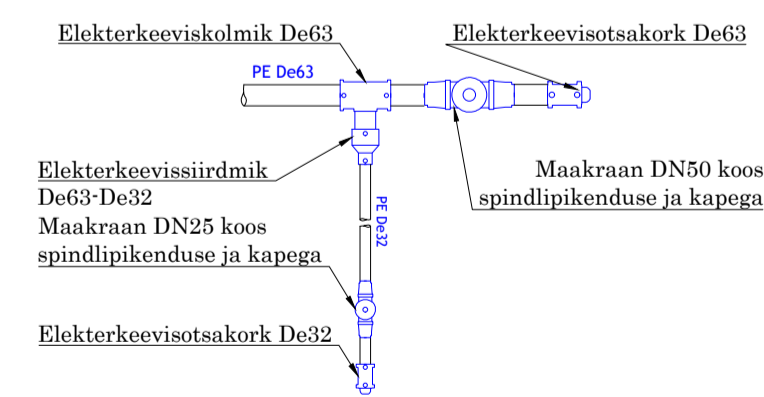

HÄRKUSED:
1. Kõik sulgeseadmed, v.a sulgeseadmed kaevudes on kompleksis spindlipikenduse ja kaepaga

Muudatuse nr	Kauplev	Projekteerija	Vastutav spetsialist	Selgitus
Projekteerija		Töö nimetus		Töö tellija
Keskkonnaprojekt		Peipsi põhjaranniku vee ja kanali projekteerimine - ehitusetaap II		Alutaguse Vallavalitsus
OÜ KESKKONNAPROJEKT A: Ringtee 12, 50105 Tartu T: +372 7305 060 E: info@keskkonnaprojekt.ee MTR reg nr EP10769210-0001		Joonise nimetus		Töö väljaandmise aeg
Vastutav spetsialist		Veetorustiku tüüpsõlmede skeemid		25.01.2024
Janno Erm	Altkiri /alkirjastatud digitaalselt/	Joonise digitaalne aadress		319802_PP_VK-7-11_Veesõlmed.dwg
Projekteeris	Altkiri /alkirjastatud digitaalselt/	Objekti aadress	Projektis taastumise aeg	Töö number
Kätlin Vodja		Kauksi, Kuru ja Uusküla, Alutaguse vald, Ida-Viru maakond	PP	3198
			Möötkava	Joonise number
				VK-7-11